



ALL SEASONS
COMFORT

TROIA

RETRACTABLE BIOCLIMATIC PERGOLA

*Transforms spaces into
living concepts.*

10X

Aluminium Motorized Pergolas



TROIA RETRACTABLE



Kapalı Sistem
Closed System



Yarı Açık Sistem
Semi-Open System



Açık Sistem
Open System

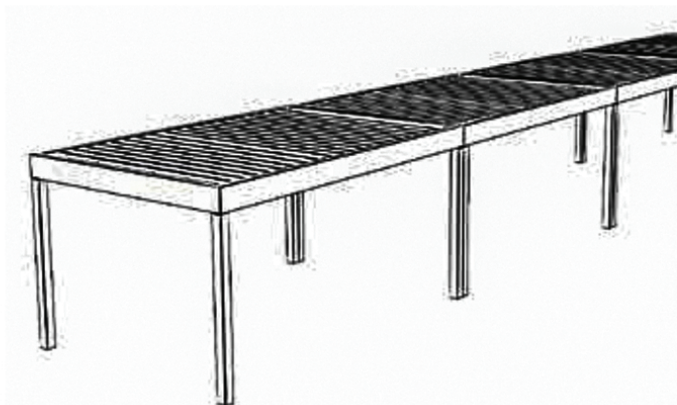

Troia Açılır Biyoklimatik Pergolalar, tam otomatik akıllı lamelleri sayesinde terasınızdaki gölgelendirmeyi ayarlayabilir. Güneş ışınlarından doğrudan tam korunma, istenildiği kadar güneş ışınına izin verme ve tam açıklık seçenekleri sunar. Açıldığında doğal ortam sıcaklığının düzenlenmesini, tamamen kapatıldığında ise suya dayanıklı tam kapalı bir ortam oluşturmanızı sağlar.

Otel, müstakil evler, restoranlar, barlar ve birinci sınıf eğlence mekanlarında kullanım için ideal seçenektir. İhtiyaçlarınız doğrultusunda farklı varyasyonlar sunar. Mevcut mekanınızın mimarisine uyartılabilir veya bağımsız kendini taşıyabilen kurulum varyasyonları sağlanabilir. Kurulum kolaylığı sağlayan özel tasarımı yalnızca bir günde montajının tamamlanmasına olanak sağlar. Alüminyum ve paslanmaz çelikten oluşan malzemeleriyle zamanın olumsuzluklarına karşı uzun yıllar dayanıklıdır.

Yenilikçi ve benzersiz diğer 10X ürünleriyle entegre olarak rahat bir dış mekan yaşam alanı yaratma esnekliği sağlar. Soğuk ve rüzgan dışarıda tutarak iç ortam sıcaklığınızı dengeler.

Troia Retractable Bioclimatic Pergolas can adjust the shading on your terrace thanks to their fully automatic smart fins. It offers full protection from direct sunlight, allowing as much sunlight as desired and full opening. It enables the regulation of the natural ambient temperature when opened, and creates a fully enclosed water-resistant environment when fully closed.

It is the ideal choice for use in hotels, private homes, residences, restaurants, bars and world-class entertainment venues. It offers different variations according to your needs. It can be adapted to the architecture of your existing space or independently self-supporting installation variations can be provided. Its special design that provides ease of installation allows the assembly to be completed in just one day. With its aluminum and stainless-steel material, it is resistant to the adversities of time for many years.

It provides the flexibility to create a comfortable outdoor living space by integrating with other innovative and unique 10X products. It balances your indoor temperature by keeping the cold and wind out.

1st CLASS
ALUMINIUM SYSTEMS

ISO 9001

QUALINOD

QUALITY LABEL
Qualinod
ARCHITECTURE

CE

10X
Aluminium Motorized Pergolas



Lamel ölçüsü 278 mm x 40 mm.
Maksimum lamel uzunluğu 4000 mm.
Blade dimensions 278 mm x 40 mm.
Max blade length 4000 mm.



Ağırlık 35 ≈ kg/m²
Weight 35 ≈ kg/m²



Materyal // 6063 T5 alüminyum,
paslanmaz çelik ve delrin.
Materials // 6063 T5 aluminum,
stainless steel and delrin.

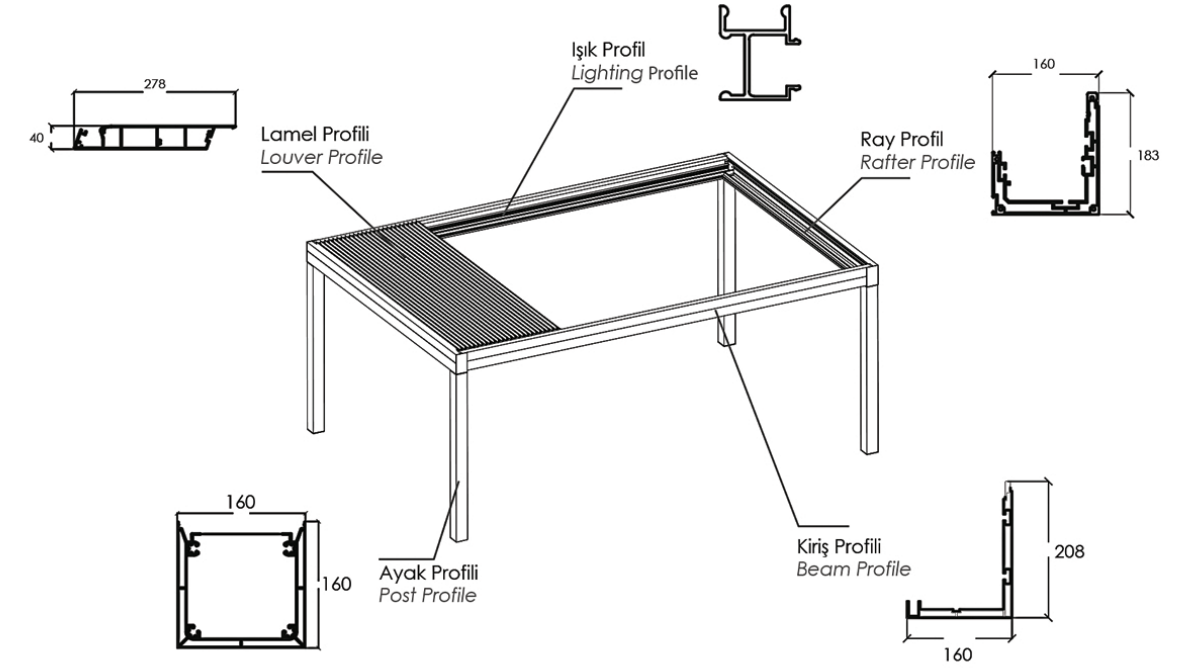

RAL Renk Seçimi
RAL renk standardına göre seçtiğiniz tüm renkler uygulanabilir.
RAL Color Selection
Coloring of your choice, according to the RAL color standard.



Motörlü Sistem
Motörlü sistem ve uzaktan kumanda kontrolü.
Electrical Motion
Capability of electrical motion and remote control.



Yağmurlu hava koşullarına, kar suyunu ve rüzgâra karşı büyük direnç.
Great resistance to weather conditions of rain, snow humidity and wind.

Rüzgar Yüküne Dayanım Testi

Standart UNE-EN 13659:2004 Class 6 // 112 km/h normlarına göre test edilmiştir. herhangi bir kırılma tespit edilmemiştir.

Kar Yüküne Dayanım Testi

Standart EN-1999 EUROCODE 9 // 100 kg / m² (kendi ağırlığı dahil) alüminyum yapılar projesi

Yağmur Testi

Standart UNE-EN 12056-3 // (0.03 l/s maks.) Sabit ağır yağmur yaklaşık 108 l.m²/sa (yapılar + çıtalar)

Yüzey

10 yıl garantili yüzey kaplaması.

Wind Load Resistance Test

UNE-EN 13659: 2004 Class 6 // (approx. 112 km / h) not tested up to 190 km / h. No breakage was detected.

Snow Load Resistance Test

Standard EN-1999 EUROCODE 9 // 100 kg / m² (including its own weight) aluminum structures project

Rain Test

Standard UNE-EN 12056-3 // (0.03 l/s max) Fixed heavy rain approx. 108 l.m²/h (structures + lamels)

Finishes

10 years of warranty for finishes.

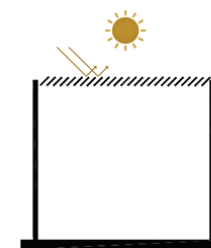

Güneş ışınlarından korur
Protection from the sun

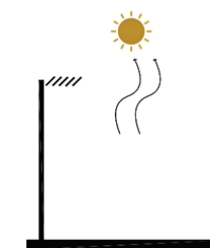

Doğal Havalandırma sağlar
Natural ventilation

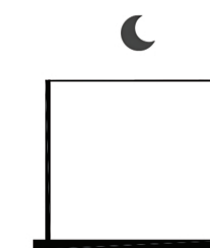

Isı kontrolü sağlar
Adjusting of temperature

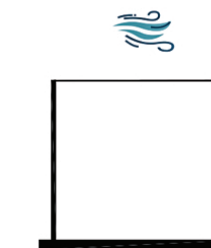

Rüzgâra karşı dirençlidir
Stability in wind

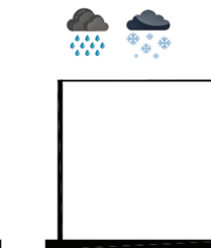

Yağmura ve kara karşı tam koruma
Perfect protection from rain and snow

10X
Aluminium Motorized Pergolas



LARİBA TEKNOLOJİ YATIRIM A.Ş.

İOSB Marmara San Sit Yönetim Binası Kat:6 Küçükçekmece / İstanbul / TÜRKİYE

WhatsApp Destek Hattı - Call or Write WhatsApp : +90 541 840 24 24

export@10x.com.tr ● www.10x.com.tr